

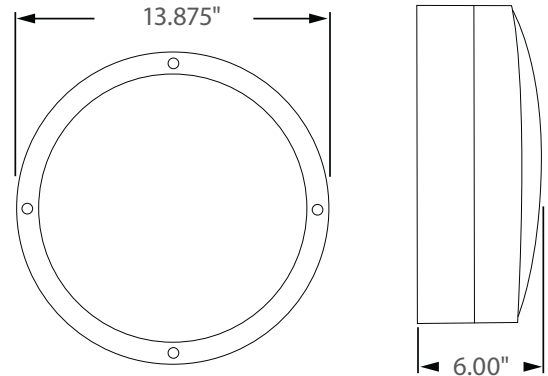

**** AVAILABLE ****
0 - 10V
FULL DIMMING



Incredible **75,000 hrs**

GENERAL DESCRIPTION

Neptun's LED round bulk head fixtures feature architectural design and durability to fit new construction and retrofit applications. Neptun's LED bulk head fixtures feature high output LED's and custom engineered optics to provide excellent uniformity and efficiency. They can replace existing HID & HPS fixtures up to 100W.

APPLICATION

- Building Accent Lighting
- Landscape Lighting
- Security Lighting
- Area Lighting
- Stairwell Lighting
- Passageway Lighting

STRUCTURE, MATERIALS, & FEATURES

- Heavy-gauge, die-cast aluminum housing.
- High efficiency, heat and impact resistant, UV protected, non yellowing polycarbonate lens / refractor.
- Corrosion resistant electrocoat white finish (custom colors available).
- Easy removal lens with (4) stainless steel screws.
- Continuous silicone gasketing surrounds lens for weather - tight seal.
- Correlated Color Temperature of (5000°K) for greater visibility and safety.
- High Output COB LED's.
- High power factor, low THD driver with 10kV surge Protection.
- InstantON flicker-free Cold Start and Hot Re-Start.
- Up to 15 years Maintenance free operation.
- 5 Year Warranty on complete fixture. (LED's, Driver, & Housing)
- **Optional:** 0-10V Dimming, Remote Monitoring and ON/ OFF Control, DC 24V Operation - Solar Compatible

ORDERING INFORMATION

Sample Number: LED-201040-UNV-BL-DIM-850-WHT
 Custom options and accessories available. Please consult factory

Series	Wattage	Voltage	Options	Color Temp	Accessories	Color
LED-201 = Bulk Head	040 = 40 W	UNV = 120-277 VAC 24VDC = 24V DC	0-10VDIM = 0-10V Dimming * Contact Factory for dimming options	835 = 3500°K 841 = 4100°K 850 = 5000°K * * Standard	LD-120V = Swivel Photocell - 120V LD-277V = Swivel Photocell - 277VAC	WHT = White * Custom Colors Available



PRODUCT INFORMATION

Model No.	Description	Rated Watts	Input Watts	Initial Lumens	Universal Line Voltage (VAC)	Max Line Current (Amp) @ 120 - 277	THD	Power Factor	Weight
LED-201040-UNV	LED Bulk Head Fixture	40	41	3,000	120-277	0.34-0.15	<20%	>0.90	5 lbs

SPECIFICATIONS

- Driver Constant Current
- Start Method InstantON
- Hot Re-start InstantON
- Power Supply 350mA
- Driver UL Rating Class 1
- Driver UL Outdoor Rated Wet Location
- Sound Rating Class A
- ANSI Surge Protection IEEE C62.41 C High
- Driver Off-State Draw 0 Watts
- Universal Input Line Voltage 120-277 VAC
- Input Line Frequency 50/60 Hz
- LED / Driver System Life 75,000 Hrs.
- Lumen Maintenance @50,000Hrs > 70%
- Color Temperature 5,000°K
- Color Rendering Index (CRI) > 80
- Minimum Starting Temperature -40°C
- Maximum Starting Temperature +50°C
- Lumens per Watt > 75
- Shock / Vibration Resistant Yes
- Power Factor > 0.90
- Total Harmonic Distortion < 20%
- Inrush Current Peak < 10 Amp
- FCC Compliance Part 15, Subp. C
- Housing IP Rating IP65
- Driver IP Rating IP67
- Warranty 5 Year

MOUNTING OPTIONS

Surface Mount

