

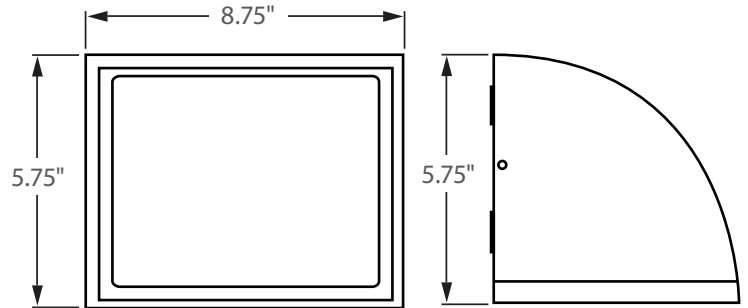

** AVAILABLE **

0 - 10V
FULL DIMMING



Incredible **75,000 hrs**

GENERAL DESCRIPTION

Neptun's LED Wall Pack fixtures feature architectural design and durability to fit new construction and retrofit applications. The LED-404 series feature high output LED's and custom engineered optics to provide excellent uniformity and efficiency. They can replace existing HID & HPS fixtures up to 70W.

APPLICATION

- Building Accent Lighting
- Landscape Lighting
- Security Lighting
- Area Lighting
- Storage Area Lighting
- Stairwell Lighting
- Passageway Lighting

STRUCTURE, MATERIALS, & FEATURES

- Heavy-gauge, die-cast aluminum housing.
- Heat and impact resistant sealed glass lens around optics.
- Corrosion resistant electrocoat dark bronze finish (custom colors available).
- Correlated Color Temperature of (5000°K) for greater visibility and safety.
- Suitable for both down-lighting and up-lighting applications.
- High Output COB LED's.
- High power factor, low THD driver with 10kV Surge Protection.
- InstantON flicker-free Cold Start and Hot Re-Start.
- Up to 15 years Maintenance free operation.
- 5 Year Warranty on complete fixture. (LED's, Driver, & Housing)
- **Optional:** 0-10V Dimming, Remote Monitoring and ON/ OFF Control, DC 24V Operation - Solar Compatible

ORDERING INFORMATION

Sample Number: LED-404020-UNV-0-10VDIM-850-BRZ
Custom options and accessories available. Please consult factory

Series	Wattage	Voltage	Options	Color Temp	Accessories	Color
LED-404 = Wall Pack	020 = 20 W	UNV = 120-277 VAC 24VDC = 24VDC	0-10VDIM = 0-10V Dimming ** Contact Factory for dimming options	835 = 3500°K 841 = 4100°K 850 = 5000°K * * Standard	LD-120V = Photocell 120VAC LD-277V = Photocell 277VAC	BRZ = Bronze ■ * Custom Colors Available



PRODUCT INFORMATION

Model No.	Description	Rated Watts	Input Watts	Initial Lumens	Universal Line Voltage (VAC)	Max Line Current (Amp) @ 120 - 277	THD	Power Factor	Weight
LED-404020-UNV	LED Wall Mount Fixture	20	21	1,800	120-277	0.17 - 0.07	<20%	>0.90	8 lbs

SPECIFICATIONS

- Driver Constant Current
- Start Method InstantON
- Hot Re-start InstantON
- Power Supply 350mA
- Driver UL Rating Class 1
- Driver UL Outdoor Rated Wet Location
- Sound Rating Class A
- ANSI Surge Protection IEEE C62.41 C High
- Driver Off-State Draw 0 Watts
- Universal Input Line Voltage 120-277 VAC
- Input Line Frequency 50/60 Hz
- LED / Driver System Life 75,000 Hrs.
- Lumen Maintenance @50,000Hrs > 70%
- Color Temperature 5,000°K
- Color Rendering Index (CRI) > 80
- Minimum Starting Temperature -40°C
- Maximum Starting Temperature +50°C
- Lumens per Watt > 90
- Shock / Vibration Resistant Yes
- Power Factor > 0.90
- Total Harmonic Distortion < 20%
- Inrush Current Peak < 10 Amp
- FCC Compliance Part 15, Subp. C
- Driver IP Rating IP67
- Optics IP Rating IP68
- Warranty 5 Year

MOUNTING OPTIONS

Wall Mount



PHOTOMETRICS (See Complete IES File)

Type 3 Distribution

